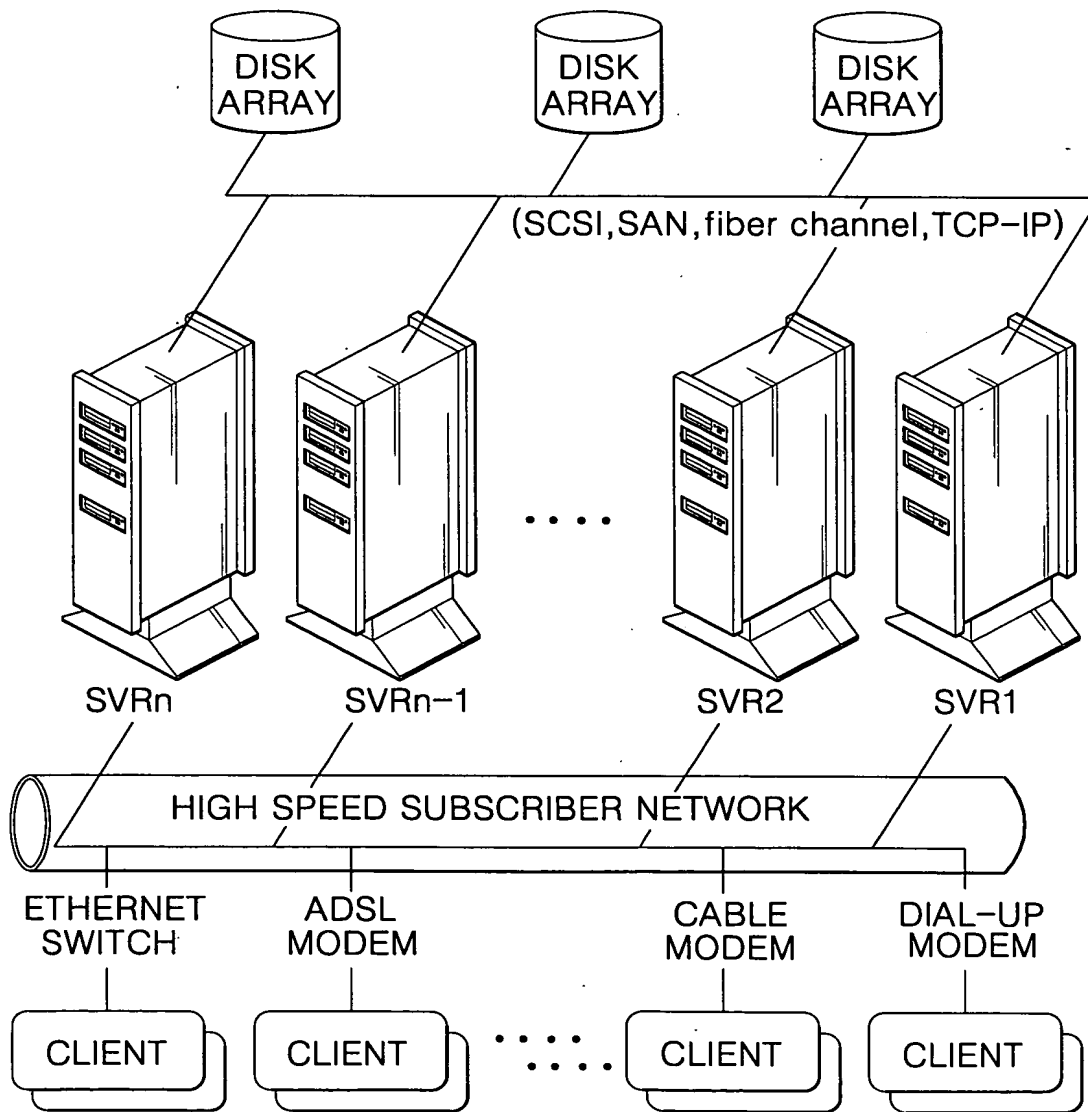

FIG. 1



Vertical text on the left margin, likely a page number or reference code.

FIG.2

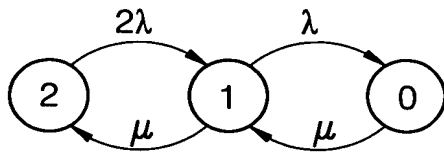

FIG.3

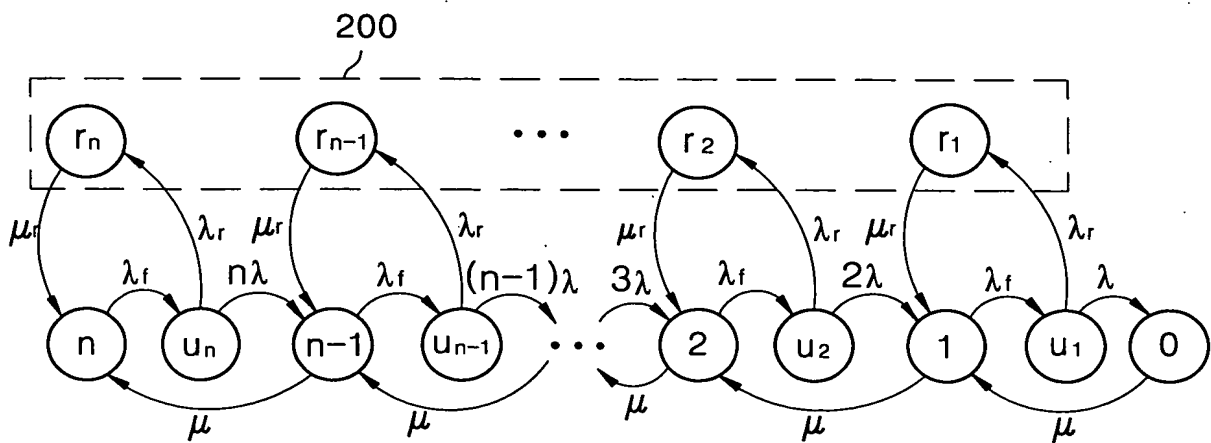

FIG.4

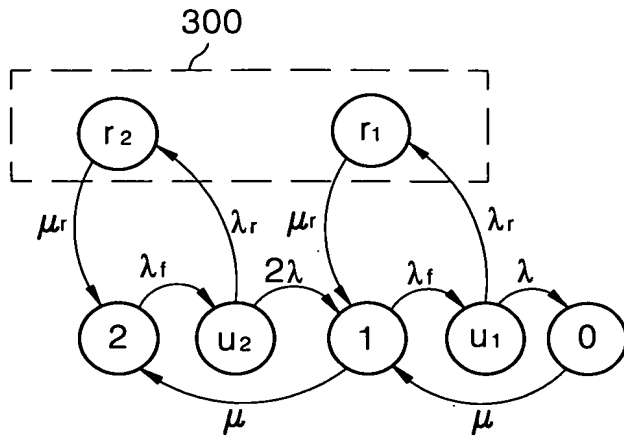

FIG.6

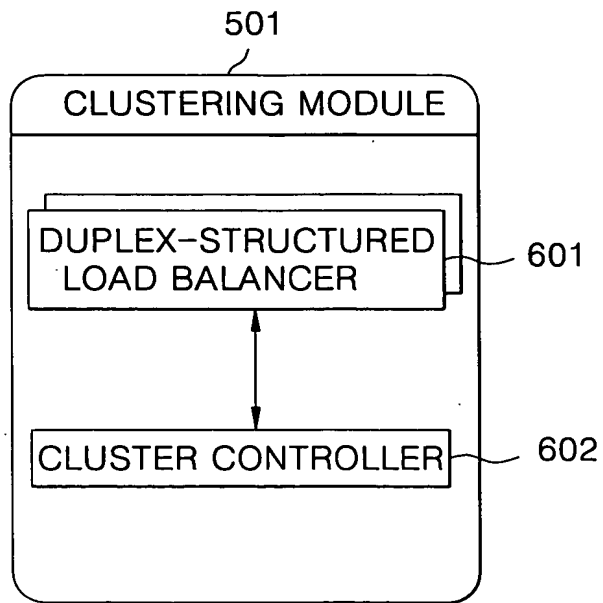

FIG. 5

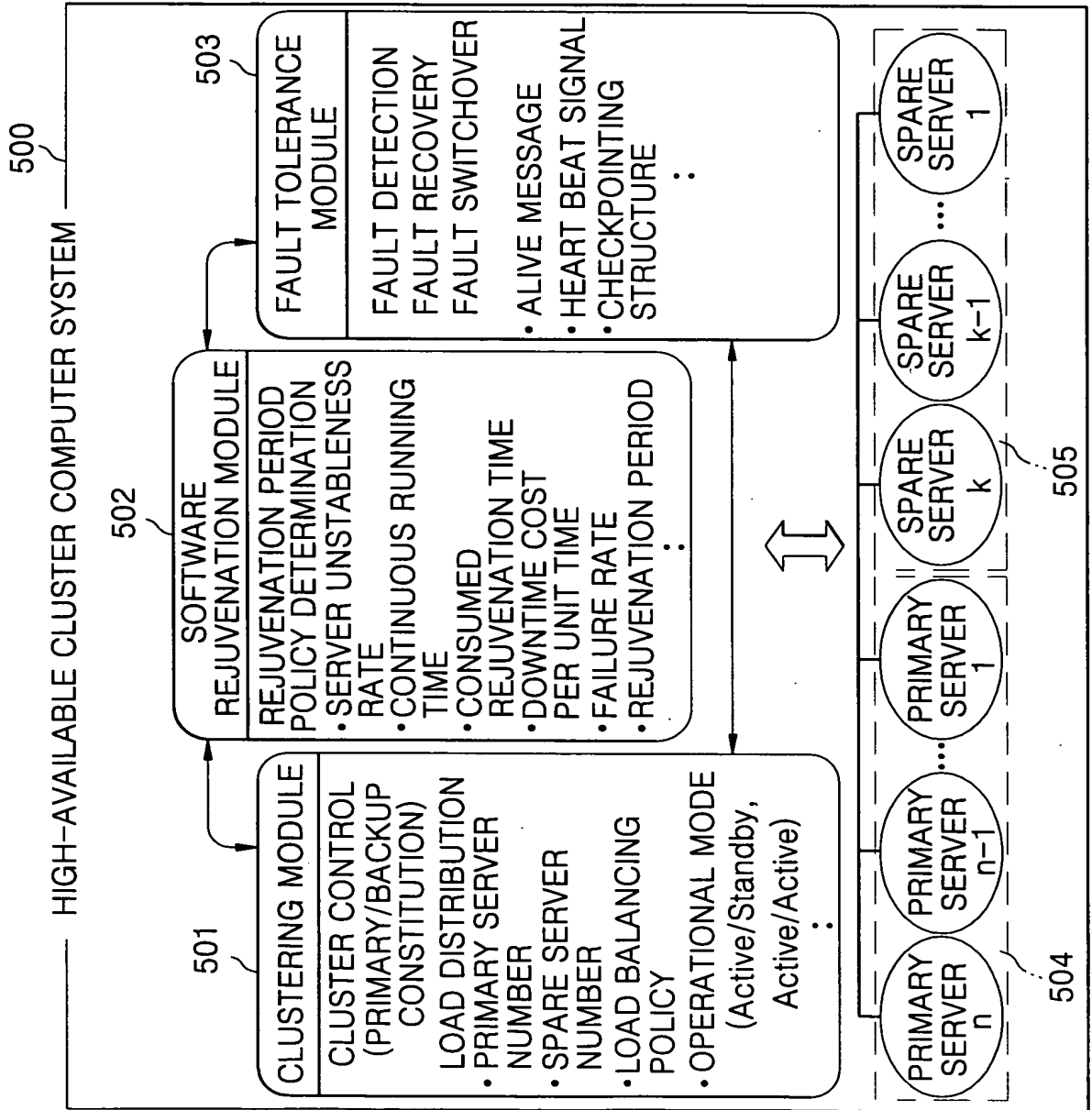

FIG. 7

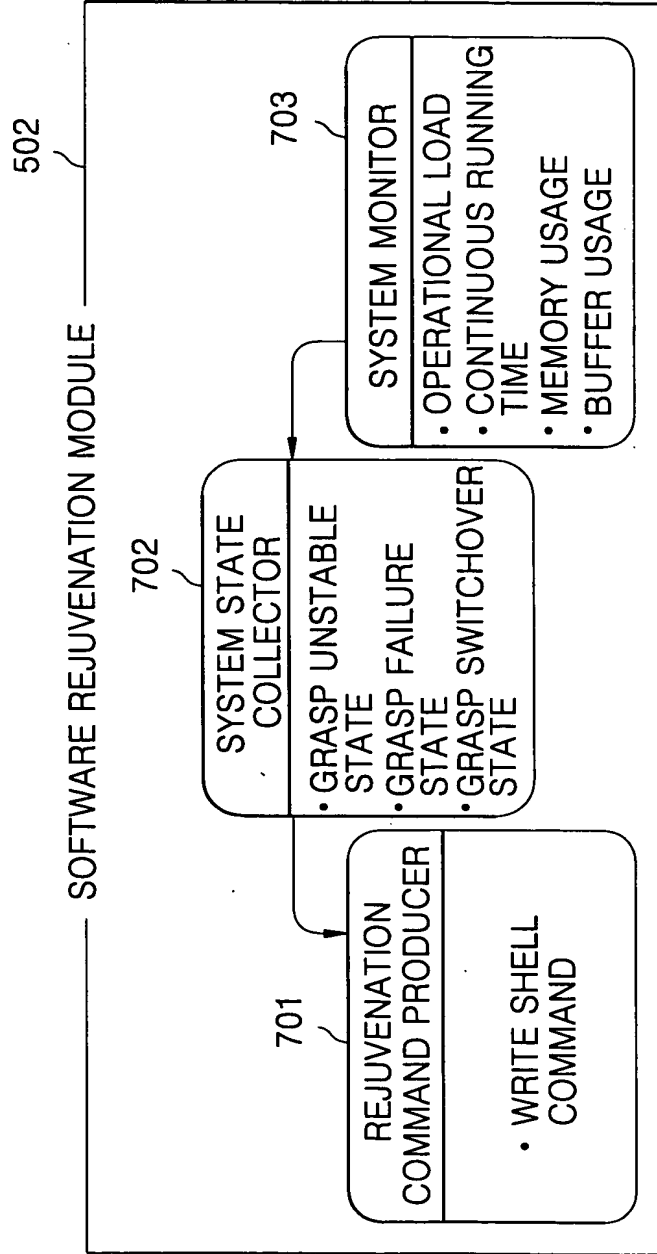

FIG. 8

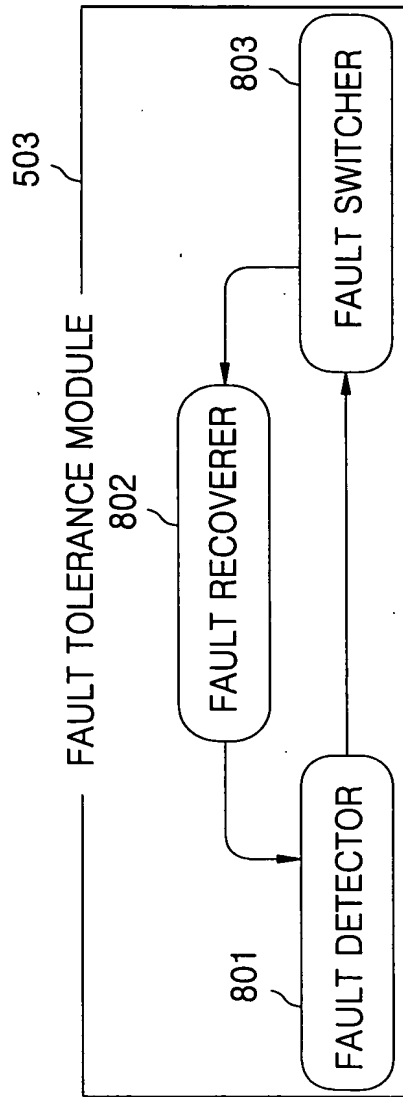

FIG. 9

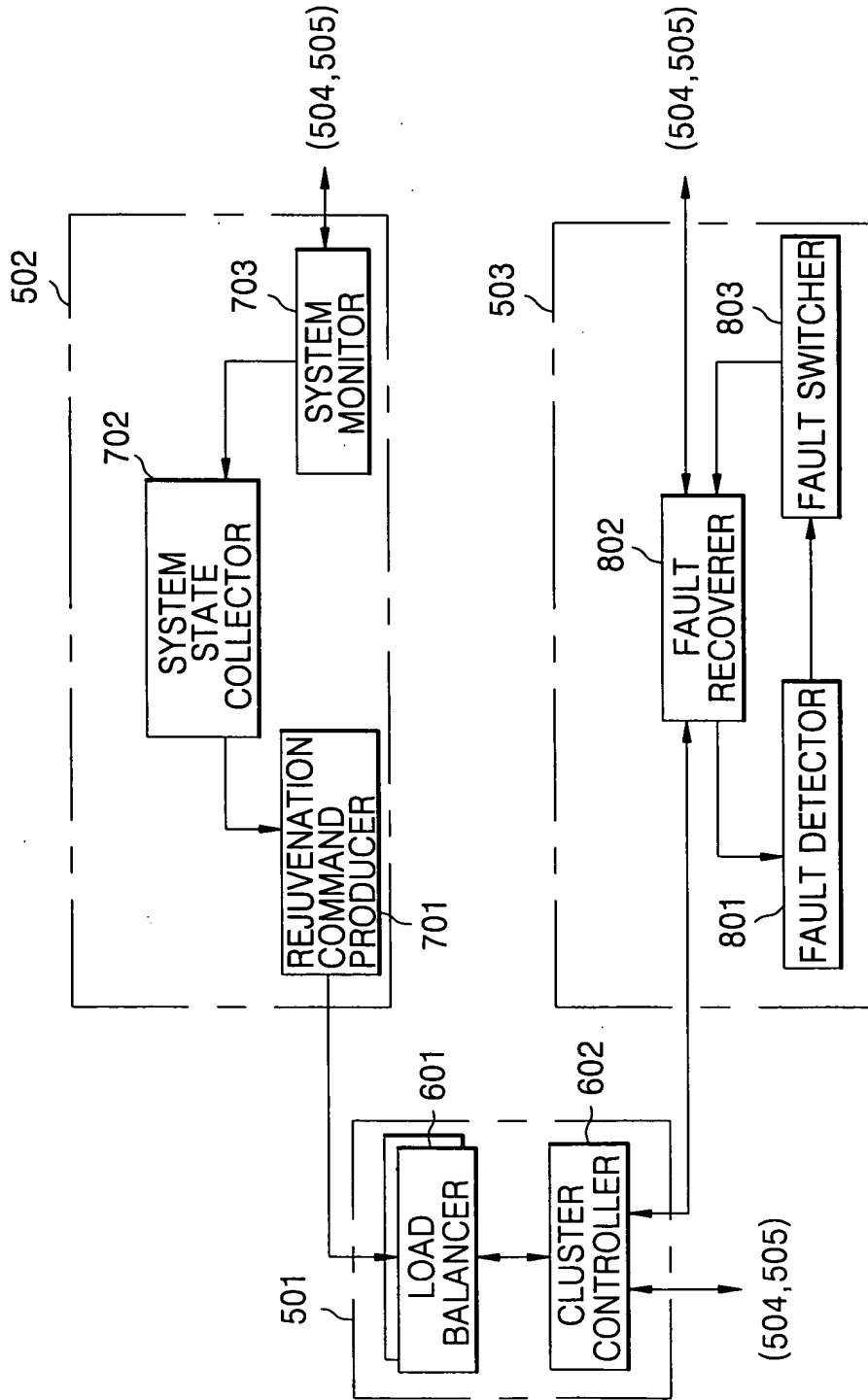

FIG.10

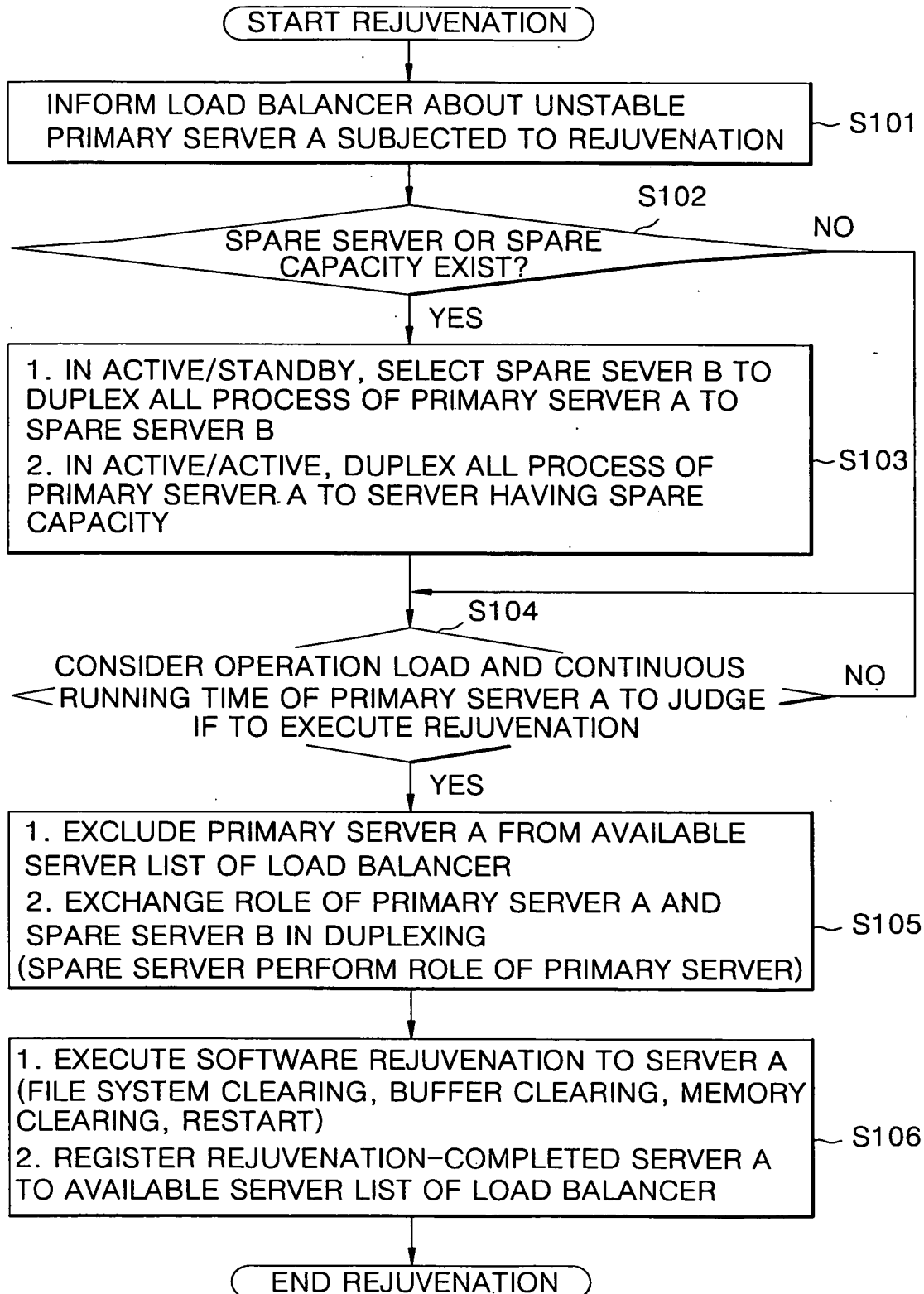



FIG.11

